

1

4

2

3

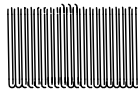

:



Mar

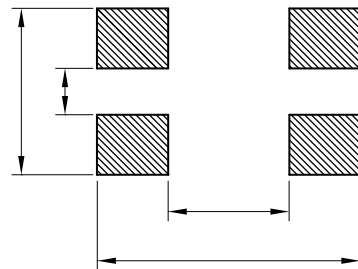

Part No	Common Mode Impedance @ 10 MHz/0.1V		Common Mode Inductance @ 100kHz/0.1V +50%/-30%	Rated Current Max.		Resistance Min.
	Min.	Typ.				

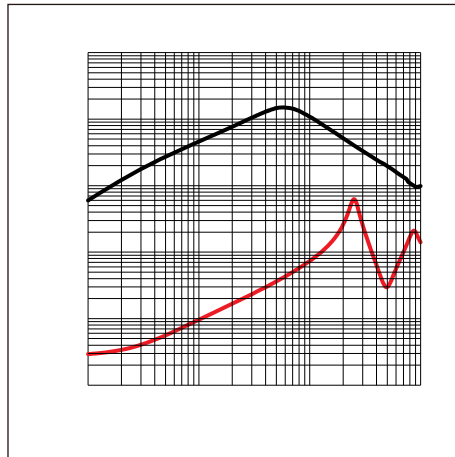
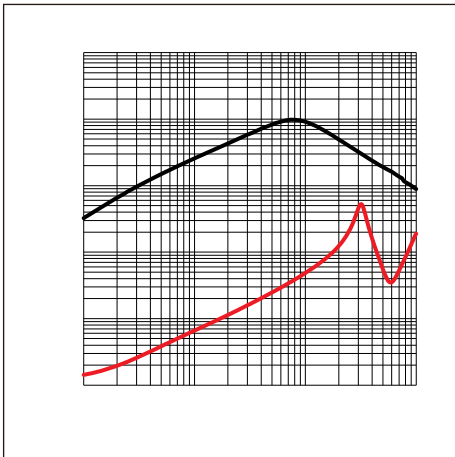

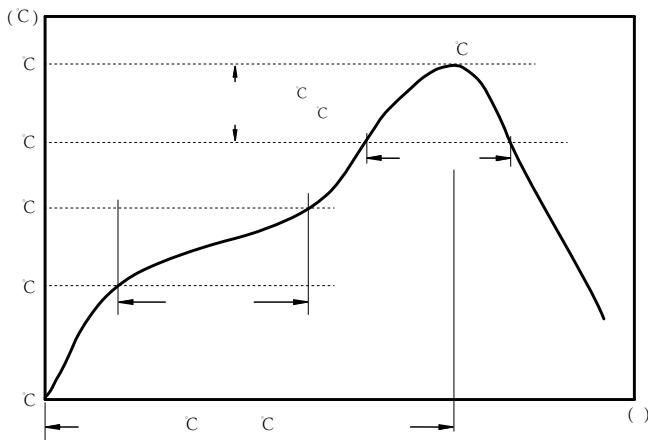

c  
c  
c

:

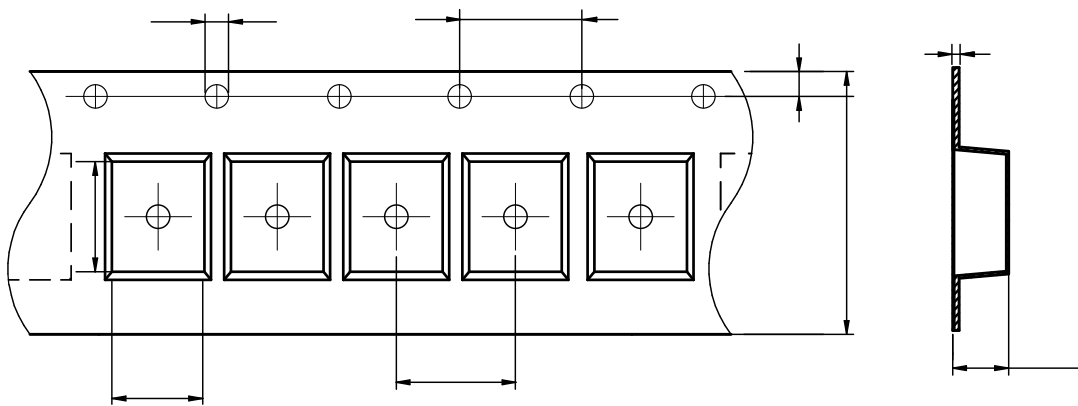

ACM3225	2.7± 0.1	3.9± 0.1	1.5± 0.1	4.0± 0.1	4.0± 0.1	12.0± 0.3	2.8± 0.1	1.75± 0.1	0.35± 0.1

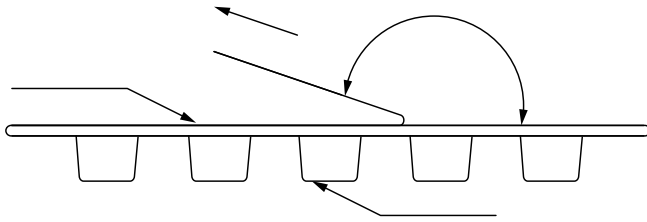

The peel force of top cover tape shall be between 0.1 to 1.3 N

:

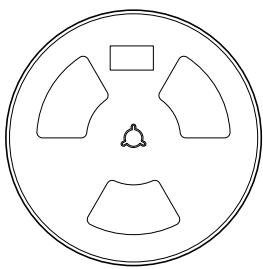
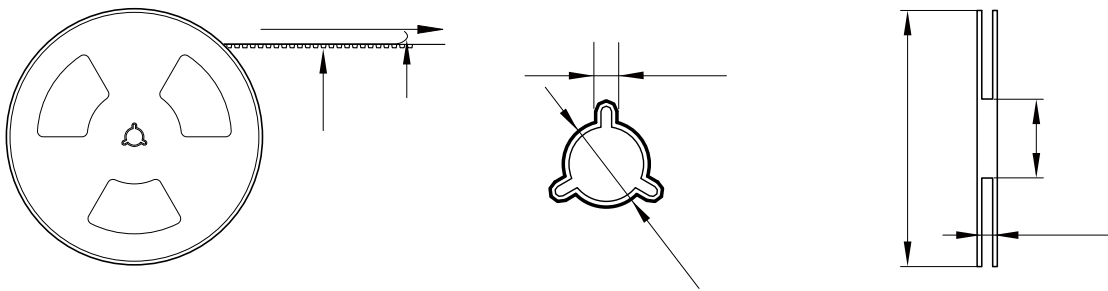

5000 Pcs/Reel

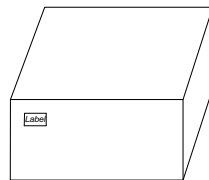

3 Reel /Inner box( 15K Pcs)

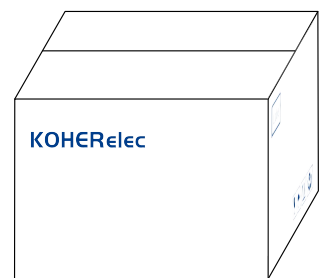

3 Inner box/Carton box(45K Pcs)

:

•

•

•

•

•

•

•

•

•

•

•

•

•